

REAR VIEW

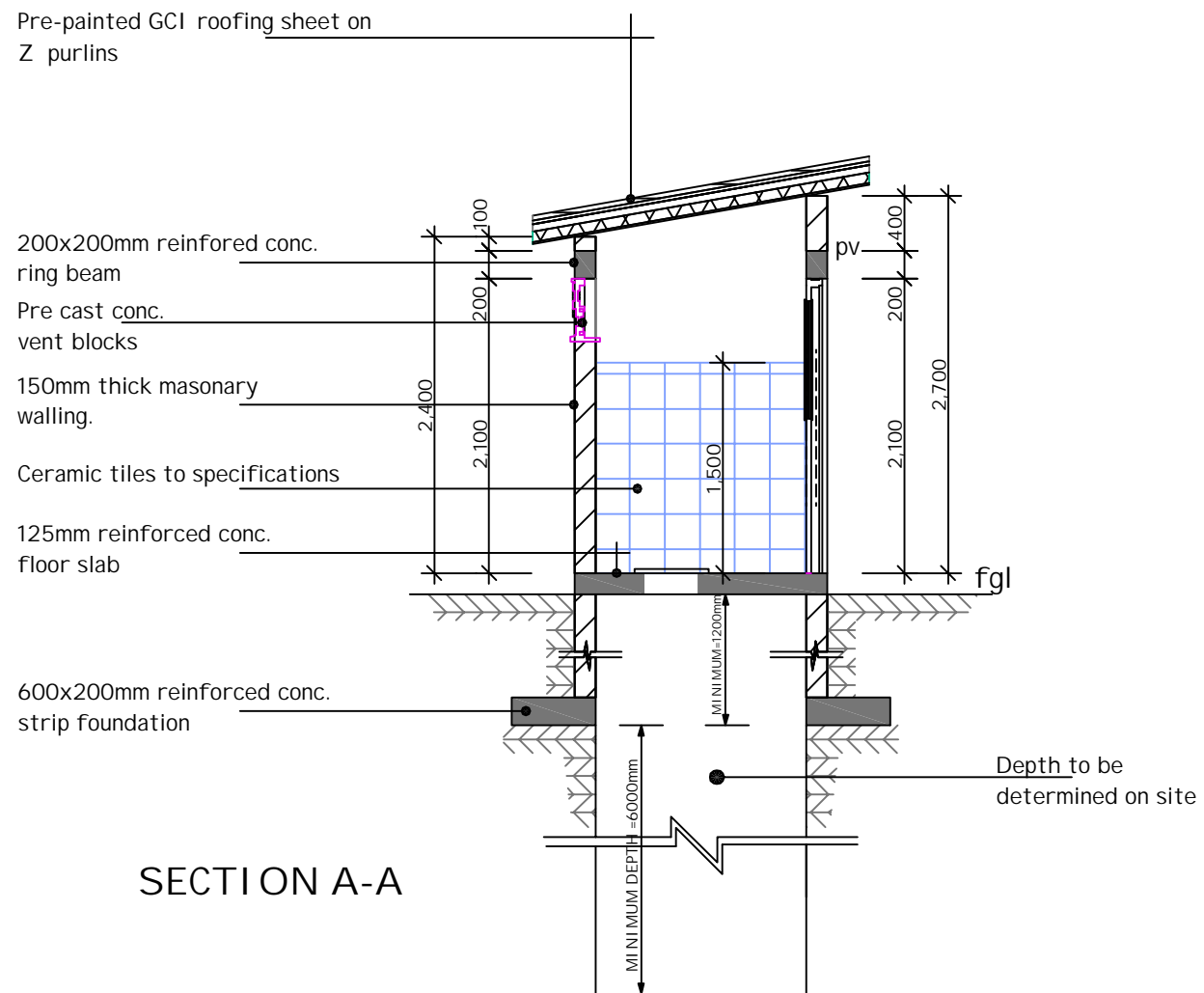

SECTION A-A

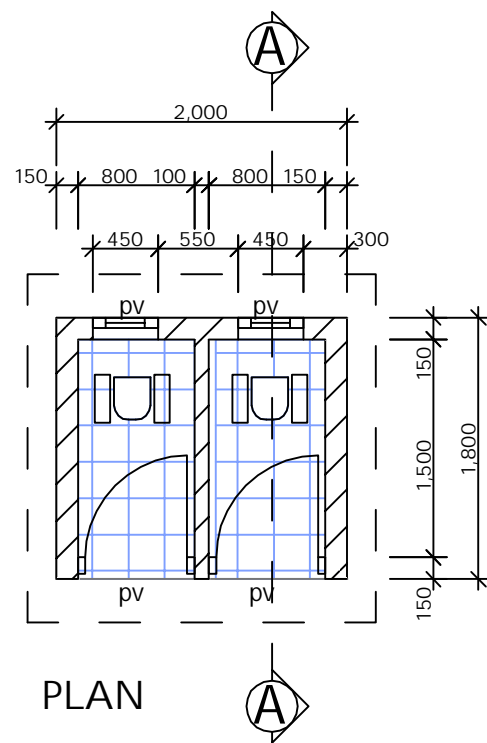

PLAN

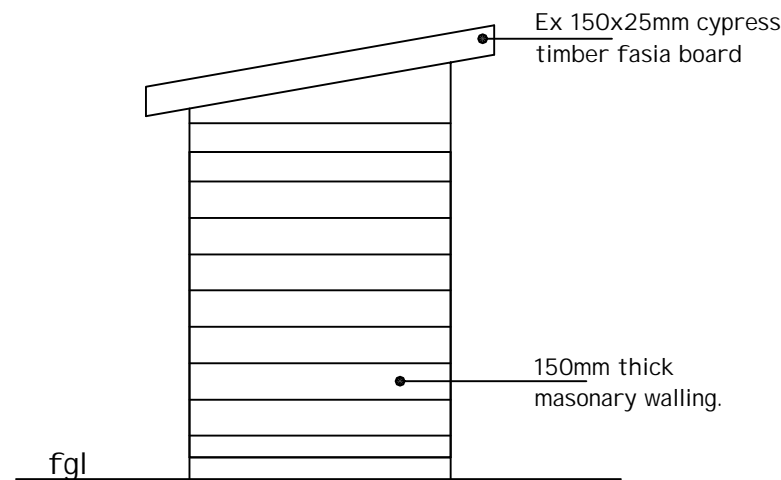

SIDE VIEW

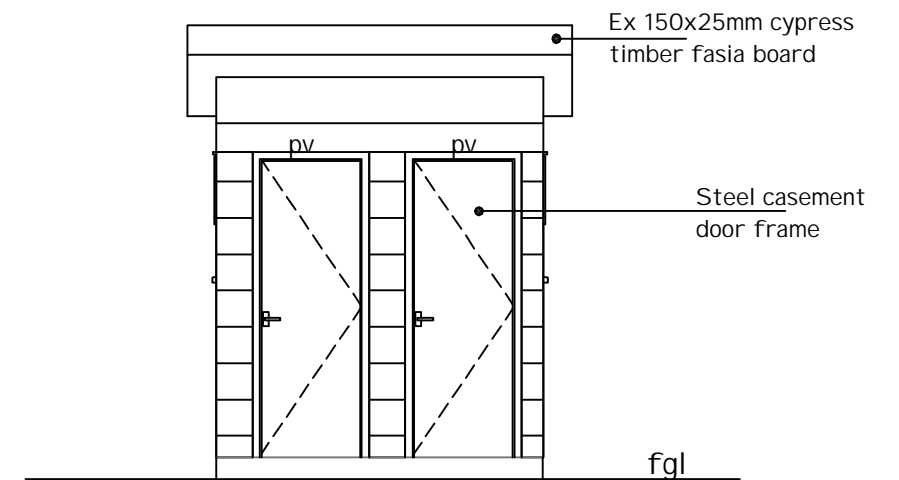

FRONT VIEW

NAME	DATE	SIGN	REF	REVISION	DATE	SIGN	CHECKED	DATE
APPROVED								
CHECKED ENGINEER I/C			1					
CHECKED PRINCIPAL D'MAN	B. GAITHO		2					
DRAWN	J.M.Kahare	23/02/2019	3					
TRACED			4					
			5					
			6					

DETAILS OF PIT-LATRINE AT PRIMARY SUB - STATION

SCALE 1 :50

SHEET 3C



K.P.&L.Co.Ltd

SK. No. 09847/A